

INTERRA

ITR410-001 – MID RANGE CEILING MOUNT PASSIVE INFRARED SENSOR

Product Manual



Information contained in this publication regarding device applications and the like is provided only for your convenience and may be superseded versions by updates. It is your responsibility to ensure that your application meets with your specifications.

INTERRA MAKES NO REPRESENTATIONS OR WARRANTIES OF ANY KIND WHETHER EXPRESS OR IMPLIED, WRITTEN OR ORAL, STATUTORY OR NONSTATUTORY, RELATED TO THE INFORMATION INCLUDING BUT NOT LIMITED TO ITS CONDITION, QUALITY, PERFORMANCE, MERCHANTABILITY OR FITNESS FOR PURPOSE.

Interra disclaims all liability arising from this information and its use. Use of Interra devices in life support and / or safety applications is entirely at the buyer's risk, and the buyer agrees to defend, indemnify and hold harmless Interra from any and all damages, claims, suits, or expenses resulting from such use. No licenses are conveyed, implicitly or otherwise under any Interra intellectual rights.

Trademarks

The Interra name and logo and the Interra ITR410-001 Mid Range Ceiling Mount Passive Infrared Sensor are registered trademarks of Interra Technology in Turkey and other countries.

All other trademarks mentioned herein are property of the Interra Technology.

© 2019, Interra, Printed in Turkey, All Rights Reserved.



Printed on recycled paper.

TS EN ISO 9001:2008

TO OUR CUSTOMERS

One of our most important aims is to provide you with the best documentation possible to use successfully your Interra products. Focusing of this, we will keep on improving our documentation to better suit your needs. Our publications will be updated as new volumes as soon as changes are introduced.

If you have any questions or comments regarding this publication, do not hesitate to contact us:

E-mail: info@interra.com.tr

Tel: +90 (216) 326 26 40 Fax: +90 (216) 324 25 03

Most Current Product Manual

To obtain the most up-to-date version of this product manual, please visit our Web site at:

<http://www.interra.com.tr>

You can determine the version of an Interra document examining its literature number found on the bottom right corner of any page.

The first two letters of the literature are the type of document. The numbers that follow are the creation date of the document and the last letter is the version (e.g., PM181017001A is the version A of a product manual created on the date 17/10/18.)

CONTENTS

1.) PRODUCT DESCRIPTION.....	6
1.1.) TECHNICAL INFORMATION	7
1.2.) PRODUCT FUNCTIONS.....	8
1.3.) PRODUCT DIMENSIONS	9
1.4.) CONNECTION DIAGRAM AND PROGRAMMING.....	9
1.5.) Passive Infrared Sensing Ranges.....	10
3.1. GENERAL PARAMETER PAGE.....	12
3.1.1. Parameters List.....	12
3.2. LIGHT CONTROL	14
3.2.1. Parameters List.....	14
3.3. FUNCTION STATUS.....	16
3.3.1. Parameters List.....	16
3.4. CONSTANT BRIGHTNESS A/B	18
3.4.1. Parameters List.....	18
3.5. A/B FORCED OPERATION	20
3.5.1. Parameters List.....	21
3.6. A/B TRIGGER.....	23
3.6.1. Parameters List.....	23
3.7. LOGIC FUNCTION A.....	25
3.7.1. Parameters List.....	25
3.8. BLOCK A.....	30
3.8.1. Parameters List.....	30
3.9. A1:SWITCHING.....	31
3.9.1. Parameters List.....	31
3.10. A1:DIMMING	32
3.10.1. Parameters List.....	33
3.11. A1:SHUTTER	34
3.11.1. Parameters List.....	34
3.12. A1:Alarm.....	35
3.12.1. Parameters List.....	35
3.13. A1:Percentage.....	37
3.13.1. Parameters List.....	37
3.14. A1:Sequence.....	38
3.14.1. Parameters List.....	39

3.15. A1:Scene.....	40
3.15.1. Parameters List.....	40
3.16. A1:String.....	41
3.16.1. Parameters List.....	42
3.17. A1:Threshold.....	43
3.17.1. Parameters List.....	43
3.18. Logic Function E.....	45
3.18.1. Parameters List.....	45
4.1. GENERAL.....	47
4.2. LIGHT CONTROL.....	48
4.3. FUNCTION STATUS.....	48
4.4. LOGIC FUNCTION A-E.....	49

1.) PRODUCT DESCRIPTION

ITR410-001 – Mid Range Ceiling Mount The Passive Infrared & LUX Sensor is a multi-function motion sensor. The device can communicate with other KNX devices by using the KNX bus line. Database uploads to the product are done with ETS3.0 and later versions. The device is manufactured in accordance with electromagnetic compatibility (EMC), electrical safety and environmental conditions. It contains 4 independent, 1 combination logic blocks. The logic relations “AND”, “OR” can be set. The logic input conditions contain the conditions of movement sensor, LUX and external conditions. According to different application requirements, the sensor can be configured as the master-slave mode or single mode.

1.1.) TECHNICAL INFORMATION

Device	ITR410-001
Power Supply	EIB Power Supply
Current Consumption	5 mA (static) 15 mA (dynamic)
Güç Tüketimi****	150 mW 450 mW
Passive Infrared Sensing Range in Diameter	8m (install height – 2.5m)
Brightness ****	0 – 3000 LUX
Temperature Range	Operation (– 10°C ...70 °C) Storage (– 25°C ...100 °C)
Maximum Air Humidity	<90 RH
Type of Protection	IP 20
Flammability	Non-flammable Product
Color	Light Grey and White
Dimensions	63 x 46.6 (DxH)
Certificaton	KNX Certified
Configuration	Configuration with ETS

1.2.) PRODUCT FUNCTIONS

- ITR410-001 supports movement detection, temperature detection, LUX detection and external telegram detection.
- Supports 2 channels of light control, it can control the switch and dimming output. When the dimming function is applied, 4 brightness values can be set, and after 4 times delay, the brightness of the setting can be reached.
- ITR410-001 have 5 logic function blocks and can be set the logical relation AND/OR. Each block can control 10 output objects. The work mode includes single mode and Master & Slave mode.
- ITR410-001 can report movement status, temperature, Lux status to KNX system.
- The sensing range for detecting people sitting and walking are different sizes. The recommended installation height is 2 m - 3m. The Passive Infrared Sensing range of the detector increases as the installation height increases.
- The sensor supports object controls: Switch control, Absolute dimming control, Shutter control, Alarm control, Percentage control, Sequence control, Scene control, String control, Threshold control, Logic combination control.
- With the function of constant brightness: The sensor keeps the Lux at a constant value, and it will dim the lights to the corresponding intensity according to the surrounding brightness.

1.3.) PRODUCT DIMENSIONS

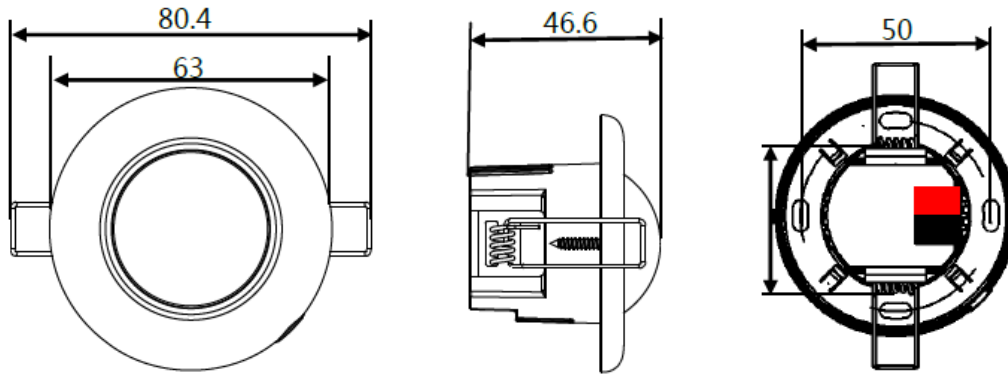

Fig 1 : Front, Side and Rear Appearances and Measures of the Device.

The numerical values showing the dimensions above are in mm.

1.4.) CONNECTION DIAGRAM AND PROGRAMMING

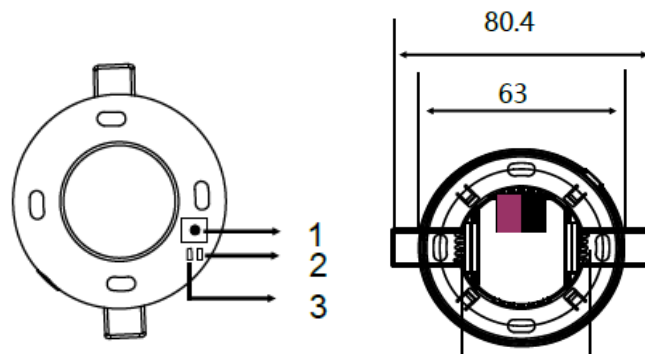

Fig 2 : KNX Connector, Programming LED and Button.

In the figure above, there are buttons and LEDs on the left shape, indicated by numbers 1,2 and 3. The number 1 button is the programming button, the LED 2 is LED programming and the LED 3 is LED status indicator. The programming button must be pressed before programming the device. After pressing the button, the LED 2 will be red. Thus, the device is ready to be installed via the ETS program.

1.5.) Passive Infrared Sensing Ranges

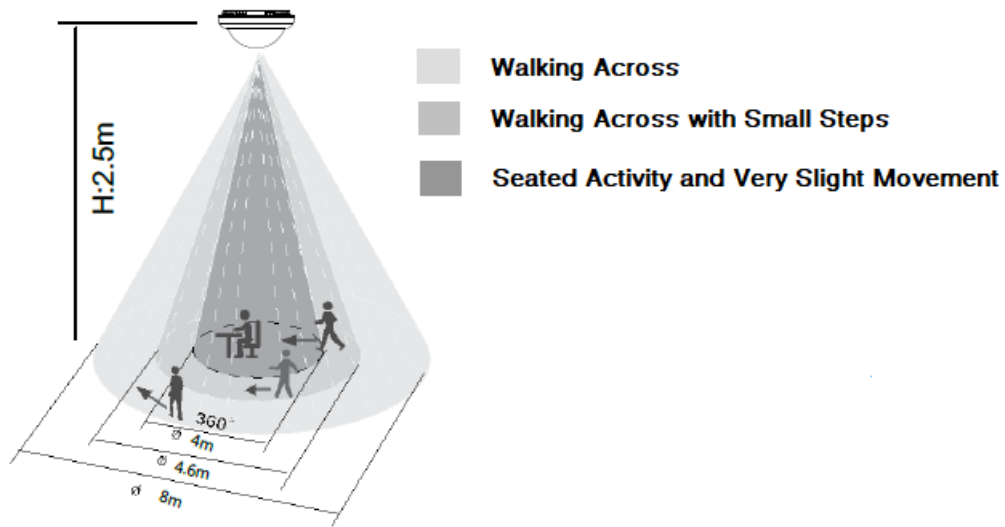

Fig 3 : Passive Infrared Sensor Detection Diagram.

Mounting Height	Seated Activity & Very Slight Movement	Walking Across with Small Steps	Walking Across
2.5m	4m	4.6m	8m
3m	4m	4.6m	8m
4m	4m	7m	10m
5m	4m	8m	10m

Table 1 : Passive Infrared Sensor Detection Ranges.

The above table shows the detection distances of the ITR410-001 Mid Range Passive Infrared Sensor according to the height at which it is installed. As the height level of the installation increases, the distance that the sensor can detect increases. The position and height where the sensor is to be placed are important in this respect.

2.) MOUNTING

ITR410-001 installation steps of the Mid Range Ceiling Mount Passive Infrared Sensor are described below.

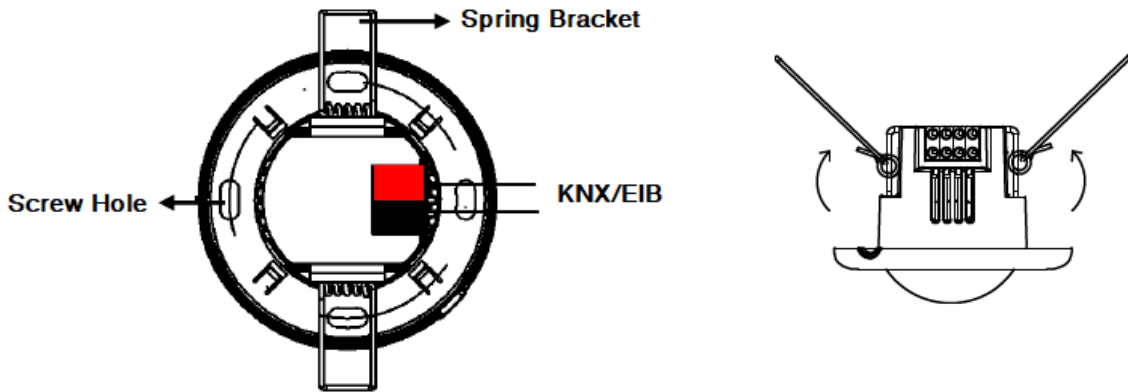

Fig 4 : Spring Bracket and Screw Holes Used in Mounting the Device

Mounting of the Spring Bracket

Sensor, can be placed with spring bracket to thin thickness ceiling, wooden boards etc. A round hole with a diameter of 45mm must be drilled and then fixed to the mounting location with the spring bracket.

Mounting of the Screw

The sensor can be mounted with screws to thick walls, wooden ceiling or special boxes that can not be used with spring brackets. When attaching the sensor with the screw, the spring bracket must be removed.

Angle Shielding Cover

Angle shielding cover, which have the function of blocking infrared induction, if users do not need a certain angle of infrared dynamic induction and static induction, they can use this accessory to keep out, and can remove the rest of a part which does not need to keep out, and then to put it inside the Fresnel lens. Users can adjust angle according to their own needs.

3. ETS PARAMETERS AND OBJECTS

3.1. GENERAL PARAMETER PAGE

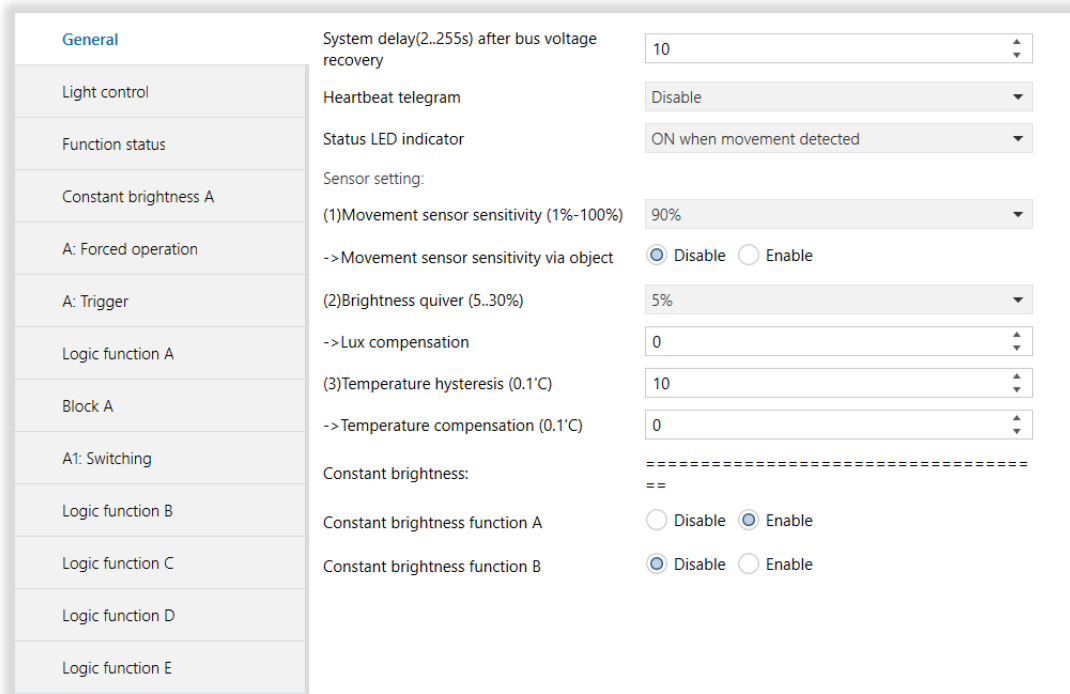

Fig 5 : General Parameter Page

3.1.1. Parameters List

PARAMETERS	DESCRIPTION	VALUES
System delay(2..255s) after bus voltage recovery	This parameter, is used for set the delay time for the device after power on.	2..10..255
Heartbeat telegram	This parameter, is used to send cyclically heartbeat telegrams. If the value is 0, the device will send 0 cyclically. If the value is 1, the device will send cyclically. Also, if the value is 0/1, the device will send alternately 0 and 1 value cyclically.	Disable Send value 0 cyclically Send value 1 cyclically Send value 0/1 inverted cyclically
Telegram is sent time interval (1..65535s)*1	This parameter, allows sending the telegram cyclically after time out.	1..5..65535s

<p>Status LED indicator</p>	<p>This parameter, is used to configure the LED indicator.</p> <p>Always is OFF: The status of the LED indicator is always OFF.</p> <p>ON when movement detected: The status of the LED indicator is ON when a motion is detected.</p> <p>ON when received '1' / '0', else is OFF: When one of '1' / '0' value is taken, the status of the LED indicator is ON, otherwise it is OFF.</p> <p>ON when logic A / B / C / D is lock / unlock: The LED indicator status is ON when A / B / C / D / E logic is locked / unlocked, otherwise OFF.</p>	<p>Always is OFF</p> <p>ON when movement detected</p> <p>ON when received '1', else OFF</p> <p>ON when received '0', else OFF</p> <p>ON when logic A is lock, else OFF</p> <p>ON when logic A is unlock, else OFF</p> <p>ON when logic B is lock, else OFF</p> <p>ON when logic B is unlock, else OFF</p> <p>ON when logic C is lock, else OFF</p> <p>ON when logic C is unlock, else OFF</p> <p>ON when logic D is lock, else OFF</p> <p>ON when logic D is unlock, else OFF</p> <p>ON when logic E is lock, else OFF</p> <p>ON when logic E is unlock, else OFF</p>
<p>(1) Movement sensor sensitivity (1%-100%)</p>	<p>This parameter, is used to set the movement sensor sensitivity.</p>	<p>1%...90%...100%</p>
<p>-> Movement sensor sensitivity via bus</p>	<p>This parameter, is used to enable or disable the movement sensor sensitivity via bus.</p>	<p>Disabled</p> <p>Enabled</p>
<p>(2) Brightness quiver (5...30%)</p>	<p>This parameter, is used to set the brightness quiver.</p>	<p>5%, 10%, 15%, 20%, 25%, 30%</p>
<p>-> Lux compensation</p>	<p>This parameter, is used to compensate the Lux value.</p>	<p>-200...0...+200</p>
<p>(3) Temperature hysteresis (0.1°C)</p>	<p>This parameter, is used to set the temperature hysteresis.</p>	<p>1..10...50</p>
<p>-> Temperature compensation (0.1°C)</p>	<p>This parameter, is used to compensate the temperature value. When the presence detector detects the temperature error, you can set the temperature compensation. Value '0' means no compensation.</p>	<p>-100...0...100</p>

Constant brightness function A	This parameter, is used to enable or disable the constant brightness function A.	Disabled Enabled
Constant brightness function B	This parameter, is used to enable or disable the constant brightness function B.	Disabled Enabled

3.2. LIGHT CONTROL

The screenshot shows a configuration interface for light control. On the left is a sidebar with menu items: General, Light control (selected), Function status, Constant brightness A, A: Forced operation, A: Trigger, Logic function A, Block A, A1: Switching, Logic function B, Logic function C, Logic function D, and Logic function E. The main area contains the following parameters:

- Use light channel 1?**: Radio buttons for No and Yes (Yes is selected).
- Operation mode**: Radio buttons for Normal (selected) and semi-automatic.
- Follow-up time seconds**: Input field with value 0.
- Follow-up time minutes**: Input field with value 1.
- Follow-up time hours**: Input field with value 0.
- Follow-up time change via object?**: Radio buttons for No (selected) and Yes.
- Threshold value brightness(>=1200:disabled)**: Input field with value 500.
- Threshold value brightness via object?**: Radio buttons for No (selected) and Yes.
- Use brightness shutdown?**: Radio buttons for No and Yes (Yes is selected).
- Calculate delay time(1..50minutes)**: Input field with value 1.
- Threshold value brightness**: Input field with value 1000.
- Output**: A section with a dashed line separator and a double equals sign.
- Object type**: Radio buttons for 1bit (selected) and 1byte.
- Value when detection**: Radio buttons for OFF-"0" and ON-"1" (ON-"1" is selected).
- Value when non-detection time out**: Radio buttons for OFF-"0" (selected) and ON-"1".
- Safety time(seconds)**: Input field with value 0.
- Lock**: A section with a dashed line separator and a double equals sign.
- Use lock object?**: A dropdown menu with 'No' selected.
- Use light channel 2?**: Radio buttons for No (selected) and Yes.

Fig 6 : Light Control Parameter Page

3.2.1. Parameters List

PARAMETERS	DESCRIPTION	VALUES
Use light channel 1/2	This parameter, is used to enable or disable the light channel 1/2 function.	No Yes
Operation mode	This parameter, is used to set the operation mode.	Normal Semi-automatic

- Follow-up time seconds	This parameter, is used to set the follow up time in seconds.	0...59
- Follow-up time minutes	This parameter, is used to set the follow up time in minutes.	0...1...59
- Follow-up time hours	This parameter, is used to set the follow up time in hours.	0...24
- Follow-up time change via object?	This parameter, is used to enable or disable change follow time via KNX bus by object.	No Yes
Threshold value brightness (>= 1200:disabled)	This parameter, is used to set the threshold value of brightness.	0...500...1200
Use brightness shutdown	This parameter, is used to enable or disable the use brightness to shutdown.	No Yes
- Calculate delay time (1...50minutes)	This parameter, is used to set the delay time in minutes.	1...50
- Threshold value brightness	This parameter, is used to set the threshold value of brightness. If actual brightness higher than this value, the light will be shut down.	0...1000...1200
- Object type	This parameter, is used to set the object type.	1 bit 1 byte
- Value when detection	This parameter, is used to set output value when detection (1 bit).	OFF-"0" ON-"1"
- Value when non-detection time out	This parameter, is used to set output value when non-detection (1 bit).	OFF-"0" ON-"1"
Safety time(seconds)	This parameter, is used to set the safety time in seconds.	0...255
- Value when detection	This parameter, is used to set value when detection (1 byte).	0...255
- Value when non-detection time out	This parameter, is used to set value when non-detection (1 byte).	0...192...255
-> When non-detection continue dim delay	This parameter, is used to enable or disable the continue dim delay when non-detection.	No Yes
--> A delay time seconds	This parameter, is used to set "A" delay time in seconds.	0...30...59
--> A delay time minutes	This parameter, is used to set "A" delay time in minutes.	0...59
--> A value	This parameter, is used to set the "A" value.	0...128...255
---> B delay time seconds	This parameter, is used to set the "B" delay time in seconds.	0...30...59

---> B delay time minutes	This parameter, is used to set the “B” delay time in minutes.	0...59
---> B value	This parameter, is used to set the “B” value.	0...64...255
----> C delay time seconds	This parameter, is used to set the “C” delay time in seconds.	0...30...59
----> C delay time minutes	This parameter, is used to set the “C” delay time in minutes.	0...59
----> C value	This parameter, is used to set the “C” value.	0...255
Use lock object?	This parameter, is used to enable or disable the lock object.	No '1'-lock, '0'-unlock '0'-lock, '1'-unlock

3.3. FUNCTION STATUS

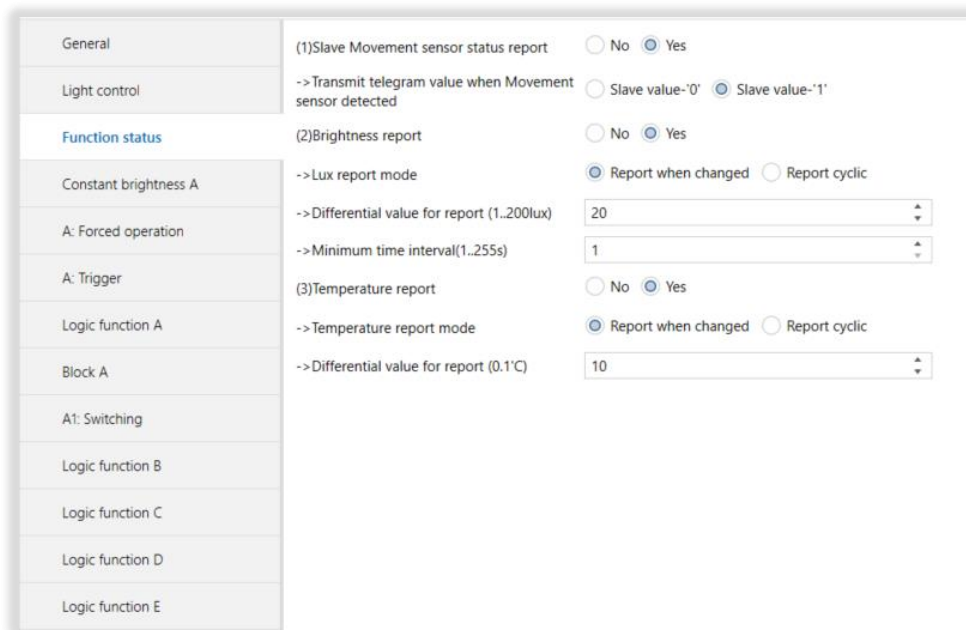

Fig 7 : Function Status Parameter Page

3.3.1. Parameters List

PARAMETERS	DESCRIPTION	VALUES
(1)Slave Movement sensor status report	This parameter, is used to enable or disable slave movement sensor status report.	No Yes

-> Transmit telegram value when Movement sensor detected*1	This parameter, is used to set the transmit telegram value when movement sensor detected.	Slave value '0' Slave value '1'
(2)Brightness report	This parameter, is used to enable or disable the lux value report feature. If the brightness value falls into the valid range, it reports the current value to the bus line only once. However, if it is within the range, it does not take the initiative to send the brightness values. But, an external device can always read the current brightness values.	No Yes
-> Lux report mode	This parameter, is used to set the lux value report mode. Report when changed: It is reported when the lux value is changed. Report cyclic: The lux value is reported cyclically.	Report cyclic Report when changed
-> Differential value for report (1...200lux)	This parameter, is used to set the differential lux value for reporting. If the changing lux value higher than the set value, reporting is made.	1... 20 ...200
-> Minimum time interval(1...255s)	This parameter, is used to set the minimum time interval in seconds to report when there is a change of value. If the changing lux value higher than the set value, reporting is made.	1...255
-> Lux report cycle (1...255s)	This parameter, is used to set the time for lux reporting cycle.	1... 10 ...255
(3)Temperature report	This parameter, is used to enable or disable the temperature value reporting feature.	No Yes
-> Temperature report mode	This parameter, is used to set the temperature value reporting mode. Report when changed: It is reported when the temperature value is changed. Report cyclic: The temperature value is reported cyclically.	Report cyclic Report when changed
-> Differential value for report (0.1°C)	This parameter, is used to set the differential temperature value for reporting. If the changing lux value higher than the set value, reporting is made.	1... 10 ...50
-> Temperature report cycle (1...255s)	This parameter, is used to set the time for temperature reporting cycle.	1... 10 ...255

3.4. CONSTANT BRIGHTNESS A/B

General	Lux value from	<input checked="" type="radio"/> Local lux sensor <input type="radio"/> External lux telegram
Light control	-> Constant brightness value(0~1200 lux)	100
Function status	Change constant brightness value via bus	<input checked="" type="radio"/> Disable <input type="radio"/> Enable
Constant brightness A	Lux quiver(n%): constant brightness lux*((1-n%) and (1+n%))	10%
A: Forced operation	Output setting:	
A: Trigger	Minimum dimming time interval limit(0.1~5.0 s)	1.0 s
Logic function A	Minimum dimming step value limit(1~10%)	1%
Block A	Maximum dimming step value limit(1~10%)	5%
A1: Switching	Minimum dimming value limit	0%
Logic function B	Maximum dimming value limit	100%
Logic function C	First dimming value of constant brightness after power on	80%
Logic function D	Operational setting:	
Logic function E	Constant brightness control after power on	Start
	Constant brightness control start/stop via bus	Disable
	Output dimming value after constant brightness control stoped	Unchanged
	Forced operation	<input type="radio"/> Disable <input checked="" type="radio"/> Enable
	Trigger	<input type="radio"/> Disable <input checked="" type="radio"/> Enable
	PI: $u(k) = K_p(\text{Proportional coefficient})[e(k) - e(k-1)] + K_i(\text{integration time})e(k)$	
	Dimming speed (for PI)	Middle(Ki=15%,Kp=15%)

Fig 8 : Constant Brightness A Parameter Page

3.4.1. Parameters List

PARAMETERS	DESCRIPTION	VALUES
LUX value from	This parameter, is used for set the lux value. Local lux sensor: The lux value is depend on the local lux sensor. External lux telegram: The lux value is depend on the external lux telegram.	Local lux sensor External lux telegram
-> Constant brightness value (0-1200 lux)	This parameter, is used to set the constant brightness value.	0...100...1200
Change constant brightness value via bus	This parameter, is used to enable or disable the change constant brightness value via bus.	Enable Disable
Lux quiver(n%): constant brightness lux*((1-n%) and (1+n%))	This parameter, is used to set the lux quiver. If the brightness change remains in the adjustment range while in the effective brightness range, the	5% 10%

	status does not change. If the brightness within the effective range is between the setting range $\text{threshold}_1 * (1 - n\%)$ and $\text{threshold}_2 * (1 + n\%)$, the situation will change because there is a change in the value greater than the range. If the brightness is not within the effective range, only the brightness changes to be effective within the threshold.	15% 20% 25% 30%
Minimum dimming time interval limit (0.1~5.0s)	This parameter, is used for dimming according to the specified range level.	0.1...1...5.0s
Minimum dimming step value limit (1~10%)	This parameter, is used to set the minimum dimming step value limit.	1...10%
Maximum dimming step value limit (1~10%)	This parameter, is used to set the maximum dimming step value limit.	1...5...10%
Minimum dimming value limit	This parameter, is used to set the minimum dimming value.	0...100%
Maximum dimming value limit	This parameter, is used to set the maximum dimming value.	0...100%
First dimming value of constant brightness after power on	This parameter, is used to set the first dimming value for constant brightness when power on.	0...80...100% Last dimming value
Constant brightness control after power on	This parameter, is used to set the parameter for constant brightness control when power on.	Stop Start Recovery
Constant brightness control start/stop via bus	This parameter, is used to set the constant brightness control. Enable('1'-Start/'0'-Stop): If receive the telegram value '1', the constant brightness will be started, if receive the telegram value '0', the constant brightness will be stopped. Enable('1'-Stop/'0'-Start): If receive the telegram value '0', the constant brightness will be started, if receive the telegram value '1', the constant brightness will be stopped. Disable: Constant brightness control will be disabled.	Enable('1'-Start/'0'-Stop) Enable('1'-Stop/'0'-Start) Disable
Output dimming value after constant brightness control stopped	This parameter, is used to set the output dimming value when constant brightness control stopped.	Unchanged 0...100%
Forced operation	This parameter, is used to enable or disable the forced operation.	Enable Disable

<p>Trigger</p>	<p>This parameter, is used to enable or disable the trigger operation.</p>	<p>Enable Disable</p>
<p>Dimming speed (for PI)</p>	<p>This parameter, is used to set the dimming speed (for PI control).</p>	<p>Defined Lowest(Ki=1%,Kp=1%) Lower(Ki=5%,Kp=5%) Low(Ki=10%, Kp=10%) Middle(Ki=15%,Kp=15%) Fast(Ki=30%,Kp=30%) Faster(Kp=60%,Ki=60%) Fastest(Kp=100%,Ki=100%)</p>

3.5. A/B FORCED OPERATION

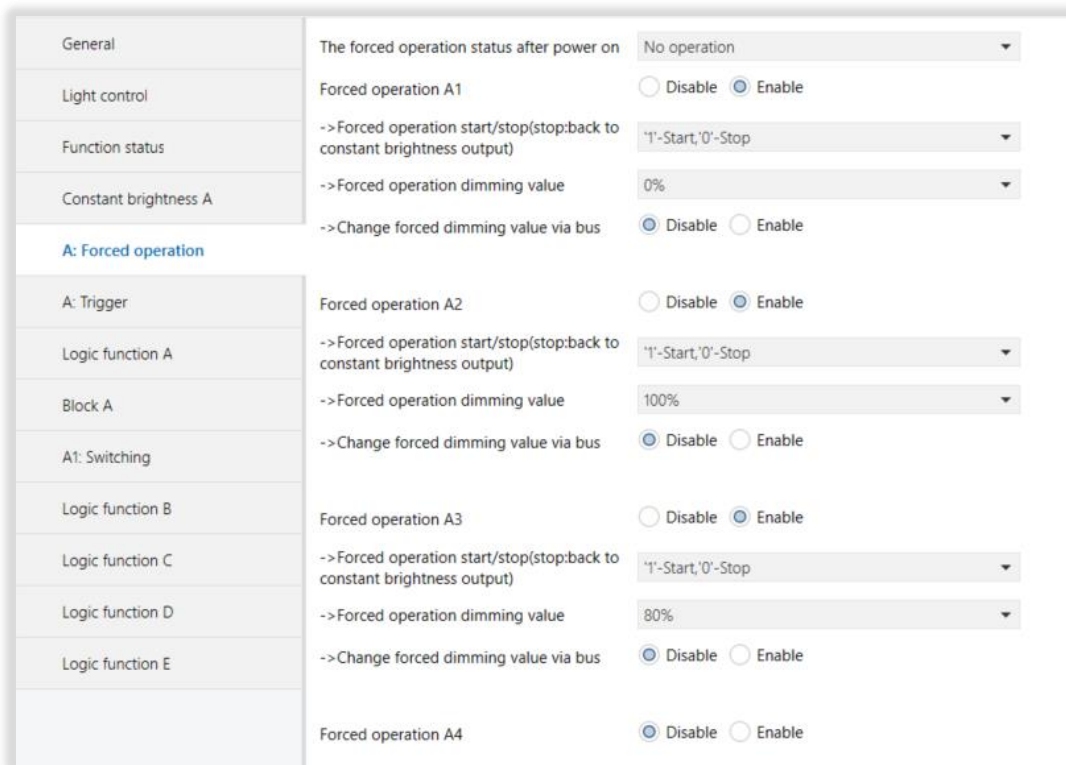

Fig 9 : "A" Forced Operation Parameter Page

3.5.1. Parameters List

PARAMETERS	DESCRIPTION	VALUES
The forced operation status after power on	This parameter, is used to set the forced operation status when after power on.	No operation Last forced operation To forced operation A1 To forced operation A2 To forced operation A3 To forced operation A4
Forced operation A1	This parameter, is used to enable or disable for forced operation A1.	Enable Disable
-> Forced operation start/stop (stop: back to constant brightness output)	This parameter, is used to set for forced operation. '1'-Start, '0'-Stop: If receive telegram value 1 will start, if receive telegram value 0 will stop and back to constant brightness output. '0'-Start, '1'-Stop: If receive telegram value 0 will start, if receive telegram value 1 will stop and back to constant brightness output. '1/0'-Start: If receive telegram value 1 or 0 will start. '1/0'-Stop: If receive telegram value 1 or 0 will stop and back to constant brightness output.	'1'-Start, '0'-Stop '0'-Start, '1'-Stop '1/0'-Start '1/0'-Stop
-> Forced operation dimming value	This parameter, is used to set the dimming value for forced operation.	0...100%
-> Change forced dimming value via bus	This parameter, is used to enable or disable for changing forced dimming value via bus.	Enable Disable
Forced operation A2	This parameter, is used to enable or disable for forced operation A2.	Enable Disable
-> Forced operation start/stop (stop: back to constant brightness output)	This parameter, is used to set for forced operation. '1'-Start, '0'-Stop: If receive telegram value 1 will start, if receive telegram value 0 will stop and back to constant brightness output. '0'-Start, '1'-Stop: If receive telegram value 0 will start, if receive telegram value 1 will stop and back to constant brightness output. '1/0'-Start: If receive telegram value 1 or 0 will start. '1/0'-Stop: If receive telegram value 1 or 0 will stop and back to constant brightness output.	'1'-Start, '0'-Stop '0'-Start, '1'-Stop '1/0'-Start '1/0'-Stop
-> Forced operation dimming value	This parameter, is used to set the dimming value for forced operation.	0... 100%
-> Change forced dimming value via bus	This parameter, is used to enable or disable for changing forced dimming value via bus.	Enable Disable

Forced operation A3	This parameter, is used to enable or disable for forced operation A3.	Enable Disable
-> Forced operation start/stop (stop: back to constant brightness output)	This parameter, is used to set for forced operation. '1'-Start, '0'-Stop: If receive telegram value 1 will start, if receive telegram value 0 will stop and back to constant brightness output. '0'-Start, '1'-Stop: If receive telegram value 0 will start, if receive telegram value 1 will stop and back to constant brightness output. '1/0'-Start: If receive telegram value 1 or 0 will start. '1/0'-Stop: If receive telegram value 1 or 0 will stop and back to constant brightness output.	'1'-Start, '0'-Stop '0'-Start, '1'-Stop '1/0'-Start '1/0'-Stop
-> Forced operation dimming value	This parameter, is used to set the dimming value for forced operation.	0... 80 ...100%
-> Change forced dimming value via bus	This parameter, is used to enable or disable for changing forced dimming value via bus.	Enable Disable
Forced operation A4	This parameter, is used to enable or disable for forced operation A4.	Enable Disable
-> Forced operation start/stop (stop: back to constant brightness output)	This parameter, is used to set for forced operation. '1'-Start, '0'-Stop: If receive telegram value 1 will start, if receive telegram value 0 will stop and back to constant brightness output. '0'-Start, '1'-Stop: If receive telegram value 0 will start, if receive telegram value 1 will stop and back to constant brightness output. '1/0'-Start: If receive telegram value 1 or 0 will start. '1/0'-Stop: If receive telegram value 1 or 0 will stop and back to constant brightness output.	'1'-Start, '0'-Stop '0'-Start, '1'-Stop '1/0'-Start '1/0'-Stop
-> Forced operation dimming value	This parameter, is used to set the dimming value for forced operation.	0... 50 ...100%
-> Change forced dimming value via bus	This parameter, is used to enable or disable for changing forced dimming value via bus.	Enable Disable

3.6. A/B TRIGGER

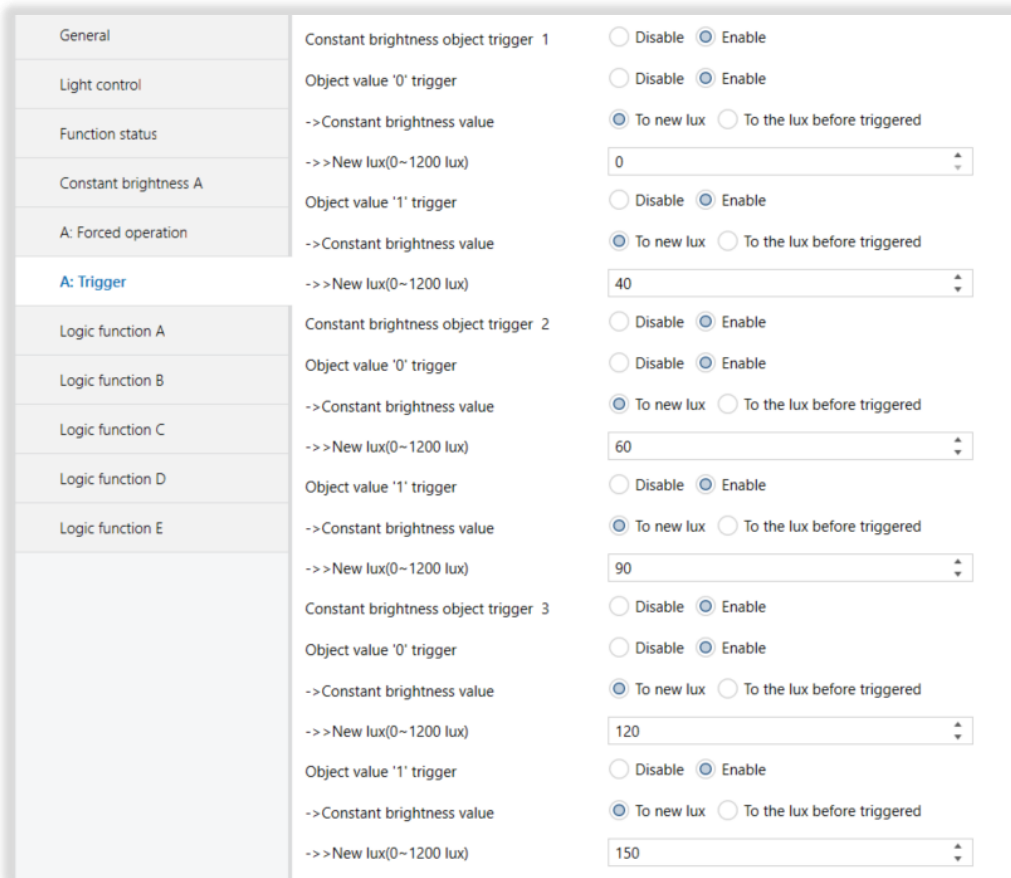

Fig 10 : A Trigger Parameter Page

3.6.1. Parameters List

PARAMETERS	DESCRIPTION	VALUES
Constant brightness object trigger 1	This parameter, is used to enable or disable for constant brightness object trigger 1.	Enable Disable
Object value '0' trigger	This parameter, is used to enable or disable object value '0' trigger.	Enable Disable
-> Constant brightness value	This parameter, is used to set the constant brightness value.	To new lux To the lux before triggered
->> New lux (0~1200 lux)	This parameter, is used to set a new lux value.	0...1200
Object value '1' trigger	This parameter, is used to enable or disable the "Object value '1' trigger" parameter.	Enable Disable

-> Constant brightness value	This parameter, is used to set the constant brightness value.	To new lux To the lux before triggered
->> New lux (0~1200 lux)	This parameter, is used to set a new lux value.	0... 40 ...1200
Constant brightness object trigger 2	This parameter, is used to enable or disable for constant brightness object trigger 2.	Enable Disable
Object value '0' trigger	This parameter, is used to enable or disable object value '0' trigger.	Enable Disable
-> Constant brightness value	This parameter, is used to set the constant brightness value.	To new lux To the lux before triggered
->> New lux (0~1200 lux)	This parameter, is used to set a new lux value.	0... 60 ...1200
Object value '1' trigger	This parameter, is used to enable or disable the "Object value '1' trigger" parameter.	Enable Disable
-> Constant brightness value	This parameter, is used to set the constant brightness value.	To new lux To the lux before triggered
->> New lux (0~1200 lux)	This parameter, is used to set a new lux value.	0... 90 ...1200
Constant brightness object trigger 3	This parameter, is used to enable or disable for constant brightness object trigger 3.	Enable Disable
Object value '0' trigger	This parameter, is used to enable or disable object value '0' trigger.	Enable Disable
-> Constant brightness value	This parameter, is used to set the constant brightness value.	To new lux To the lux before triggered
->> New lux (0~1200 lux)	This parameter, is used to set a new lux value.	0... 120 ...1200
Object value '1' trigger	This parameter, is used to enable or disable the "Object value '1' trigger" parameter.	Enable Disable
-> Constant brightness value	This parameter, is used to set the constant brightness value.	To new lux To the lux before triggered
->> New lux (0~1200 lux)	This parameter, is used to set a new lux value.	0... 150 ...1200

3.7. LOGIC FUNCTION A

The screenshot shows a configuration interface for 'Logic function A'. On the left is a sidebar with menu items: General, Light control, Function status, Logic function A (selected), Block A, A1: Switching, Logic function B, Logic function C, Logic function D, and Logic function E. The main area contains the following parameters and their settings:

- Use logical block A:** Radio buttons for No and Yes (Yes is selected).
- (1)Enable Movement sensor:** A dropdown menu set to 'Single mode(independent sensor)'. Below it are radio buttons for 'Movement sensor detected is False,else is True' and 'Movement sensor detected is True,else is False' (the latter is selected).
- (2)Enable brightness(Lux) sensor:** Radio buttons for Disable and Enable (Enable is selected).
- Enable brightness(Lux) threshold A:** Radio buttons for Disable and Enable (Enable is selected).
- >Lux >= Threshold lower(0 ~ 1200 lux):** A numeric input field set to 100.
- >Lux <= Threshold upper(0 ~ 1200 lux):** A numeric input field set to 300.
- >Changed Lux threshold value via bus:** Radio buttons for No and Yes (No is selected).
- >Brightness(Lux) status:** A dropdown menu set to 'In range is True,else False'.
- >Independent control <object output 8>:** Radio buttons for No and Yes(Separated from logic and output) (No is selected).
- Enable brightness(Lux) threshold B:** Radio buttons for Disable and Enable (Disable is selected).
- (3)Enable temperature sensor:** Radio buttons for Disable and Enable (Disable is selected).
- (4)Enable external telegram 1:** A dropdown menu set to 'Disable'.
- (5)Enable external telegram 2:** A dropdown menu set to 'Disable'.
- Logical relation of block A:** Radio buttons for AND and OR (AND is selected).
- Result of logic A inverted:** Radio buttons for No and Yes (No is selected).
- Status(True/False) of logic A to bus:** Radio buttons for Disable and Enable (Disable is selected).
- <1>Use logical A function lock?:** Radio buttons for No and Yes (No is selected).
- <2>Use logical A function lock?:** Radio buttons for No and Yes (No is selected).
- Logic A output status when logic function unlock:** A dropdown menu set to 'True'.
- Feedback logic A function lock status:** Radio buttons for No and Yes (No is selected).

Fig 11 : Logic Function A Parameter Page

3.7.1. Parameters List

PARAMETERS	DESCRIPTION	VALUES
Use logical block A	This parameter, is used to enable or disable the using logical block A.	Yes No
(1)Enable movement sensor	This parameter, is used to enable or disable the movement sensor. Single mode : The sensor works as a single sensor. Master/slave mode : It is possible to switch several presence detectors together. If two or more presence detectors are installed in a room, one presence detector must operate as "Master" and all the others must be set to the "Slave" function.	Disable Single mode(independent sensor) Master/slave mode(Master sensor)

<p>-> Movement sensor status</p>	<p>This parameter, is used to set the movement sensor status.</p> <p>Movement sensor detected is false, else is true: When the sensor report movement will be false, else is true.</p> <p>Movement sensor detected is True, else is false: When the sensor report movement will be true, else is false.</p>	<p>Movement sensor detected is False, else is True</p> <p>Movement sensor detected is True, else is False</p>
<p>-> Master is set to True when receive</p>	<p>This parameter, is used to set the Master sensor to true value when received slave sensor values.</p>	<p>Slave value-'0'</p> <p>Slave value-'1'</p>
<p>(2)Enable brightness(Lux) sensor</p>	<p>This parameter, is used to enable or disable the lux sensor.</p>	<p>Enable</p> <p>Disable</p>
<p>Enable brightness(Lux) threshold A</p>	<p>This parameter, is used to enable or disable lux threshold A value.</p>	<p>Enable</p> <p>Disable</p>
<p>-> Lux>=Threshold lower (0~1200 lux)</p>	<p>This parameter, is used to set the lux threshold lower value.</p>	<p>0...100...1200</p>
<p>-> Lux<=Threshold upper (0~1200 lux)</p>	<p>This parameter, is used to set the lux threshold upper value.</p>	<p>0...300...1200</p>
<p>-> Changed lux threshold value via bus</p>	<p>This parameter, is used to enable or disable for changing lux threshold value via bus line.</p> <p>Yes : Lux threshold value can be changed via bus line.</p> <p>No : Lux threshold value can not be changed via bus line.</p>	<p>Yes</p> <p>No</p>
<p>-> Brightness(Lux) status</p>	<p>This parameter, is used to set the lux status.</p> <p>In range is True, else False: If brightness value between lower and upper, the logic is true else false.</p> <p>Out range is True, else False: If brightness value is not between lower and upper, the logic is true else false.</p> <p>Under lower is True, above upper is False: If brightness value under lower is true, above upper is false.</p> <p>Under lower is False, above upper is True: If brightness value under lower is false, above upper is true.</p>	<p>In range is True, else False</p> <p>Out range is True, else False</p> <p>Under lower is True, above upper is False</p> <p>Under lower is False, above upper is True</p>
<p>(3)Enable temperature sensor</p>	<p>This parameter, is used to enable or disable the temperature sensor.</p>	<p>Enable</p> <p>Disable</p>

->Temperature>=Threshold lower (0.1°C)	This parameter, is used to set the temperature threshold lower value.	-300...220...700
->Temperature<=Threshold upper (0.1°C)	This parameter, is used to set the temperature threshold upper value.	-300...260...700
->changed temperature threshold value via bus	This parameter, is used to enable or disable for changing temperature threshold value via bus. Yes: Can change temperature threshold value via bus. No: Can not change temperature threshold value via bus.	Yes No
->Temperature status	This parameter, is used to set the temperature status. In range is True, else False : If temperature value between lower and upper, the logic is true else false. Out range is True, else False : If temperature value is not between lower and upper, the logic is true else false. Under lower is True, above upper is False : If temperature value under lower is true, above upper is false. Under lower is False, above upper is True : If temperature value under lower is false, above upper is true.	In range is True, else False Out range is True, else False Under lower is True, above upper is False Under lower is False, above upper is True
Enable external telegram 1/2	This parameter, is used to enable or disable the external telegram 1.	Disable 1 bit value('1'/'0') 1 byte threshold (0...255) 2 bytes threshold (0...65535) 2 bytes float threshold (-50°C...100°C) 4 bytes threshold (0...2147483647)
->1 byte threshold (0...255)	This parameter, is used to set the 1 byte threshold value.	0...100...255
->Extern telegram status	This parameter, is used to set the external telegram status.	'1' is True, '0' is False '0' is True, '1' is False
->2 byte threshold (0...65535)	This parameter, is used to set the 2 byte threshold value.	0...1000...65535
->2 byte float threshold (0.1°C)	This parameter, is used to set the 2 byte float threshold value.	-500...250...1000
->4 byte threshold (0...2147483647)	This parameter, is used to set the 4 byte threshold value.	0...1000000...2147483647

->Extern telegram status	This parameter, is used to set the external telegram status.	True if REV value >= Threshold, else False True if REV value <= Threshold, else False
->Default status after bus voltage recovery	This parameter, is used to set the default status after bus voltage recovery.	True False Recovery
Logical relation of block A	This parameter, is used to set for logical relation of block A. AND : All conditions should be satisfied. OR : One condition is satisfied, the logic will trigger.	AND OR
Result of logic A inverted	This parameter, is used to enable or disable for result of logical A inverted. Yes : Logic function A results non-inverted. No : Logic function A result Inverted.	Yes No
Status(True/False) of logic A to bus	This parameter, is used to enable or disable the status of logic A to bus.	Enable Disable
->Send status when	This parameter, is used to set when the status value will be sent. Status changed: When the status is changed, the value will be sent. Status is True: When the status is true, the value will be sent. Status is False: When the status is false, the value will be sent. Status changed and periodically: If the status is changed, the value will be sent periodically. Status is True and periodically: If the status is true, the value will be sent periodically. Status is False and periodically: If the status is false, the value will be sent periodically.	Status changed Status is True Status is False Status changed and periodically Status is True and periodically Status is False and periodically
<1>Use logical A function lock?	This parameter, is used to enable or disable the logical A function lock.	No Yes
->Use telegram via bus?	This parameter, is used to enable or disable using of the telegram via bus.	No Yes

<p>-->> Operation mode</p>	<p>This parameter, is used to set the operation mode.</p>	<p>'1'-Unlock, '0'-Lock '1'-Lock, '0'-Unlock '1/0'-Lock '1/0'-Unlock '1'-Unlock, '0'-Invalid '0'-Lock, '1'-Invalid '1'-Lock, '0'- Invalid '0'-Unlock, '1'-Invalid</p>
<p>Logic A output status when logic function lock</p>	<p>This parameter, is used to set the logic A output status when logic function locked.</p> <p>Unchanged: When logic function is locked, logic A output will not be changed.</p> <p>True: When logic function is locked, logic A output will be set to True.</p> <p>False: When logic function is locked, logic A output will be set to False.</p> <p>True and immediately output: When logic function is locked, logic A output will be set to True immediately.</p> <p>False and immediately output: When logic function is locked, logic A output will be set to False immediately.</p>	<p>False and immediately output Unchanged True False True and immediately output</p>
<p>Logic A automatic unlock after logic function lock.</p>	<p>This parameter, is used to enable or disable for unlocking logic A locked status.</p>	<p>No Yes</p>
<p>-->>Delay time (0...17hours)</p>	<p>This parameter, is used to set the time delay in hours.</p>	<p>0...17</p>
<p>-->>Delay time (0...59min)</p>	<p>This parameter, is used to set the time delay in minutes.</p>	<p>0...59</p>
<p>-->>Delay time (0...59sec)</p>	<p>This parameter, is used to set the time delay in seconds.</p>	<p>0...30...59</p>
<p><2>Use logical A function lock?</p>	<p>All settings are same as 1.</p>	<p>All settings are same as 1.</p>
<p>Logic A output status when logic function unlock</p>	<p>This parameter, is used to set the logic A output status when logic function unlocked.</p>	<p>False True Current logic status</p>

Feedback logic A function lock status	<p>This parameter, is used to enable or disable the feedback logic A function lock status.</p> <p>Yes: Feedback logic A function lock status will be enabled.</p> <p>No: Feedback logic A function lock status will be disabled.</p>	<p>Yes</p> <p>No</p>
--	--	-----------------------------

3.8. BLOCK A-E

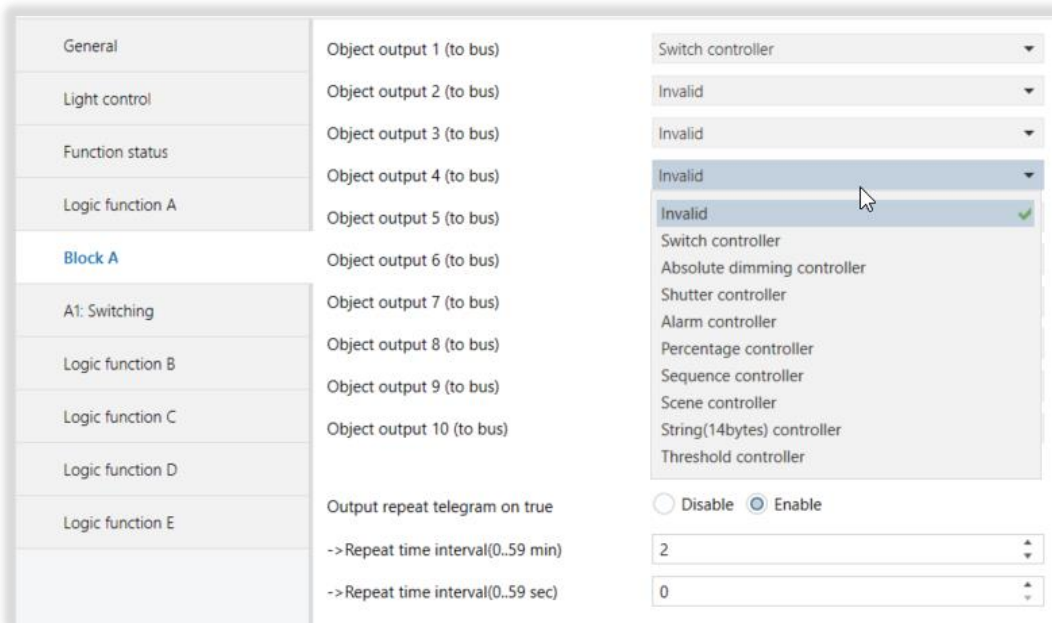

Fig 12 : Block A Parameter Page

3.8.1. Parameters List

PARAMETERS	DESCRIPTION	VALUES
Object output 1-10 (to bus)	<p>This parameter, is used to set the object output 1-10 to bus. A total of 10 targets and 9 types can be set.</p>	<p>Invalid</p> <p>Switch controller</p> <p>Absolute dimming controller</p> <p>Shutter controller</p> <p>Alarm controller</p> <p>Percentage controller</p> <p>Sequence controller</p> <p>Scene controller</p> <p>String (14bytes) controller</p> <p>Threshold controller</p>

Output repeat telegram on true	This parameter, is used to enable or disable the output repeat telegram on true value.	Enable Disable
-> Repeat time interval (0...59min)	This parameter, is used to set the time for repeat time interval in minutes.	0...2...59
-> Repeat time interval (0...59sec)	This parameter, is used to set the time for repeat time interval in seconds.	0...59

3.9. A1:SWITCHING

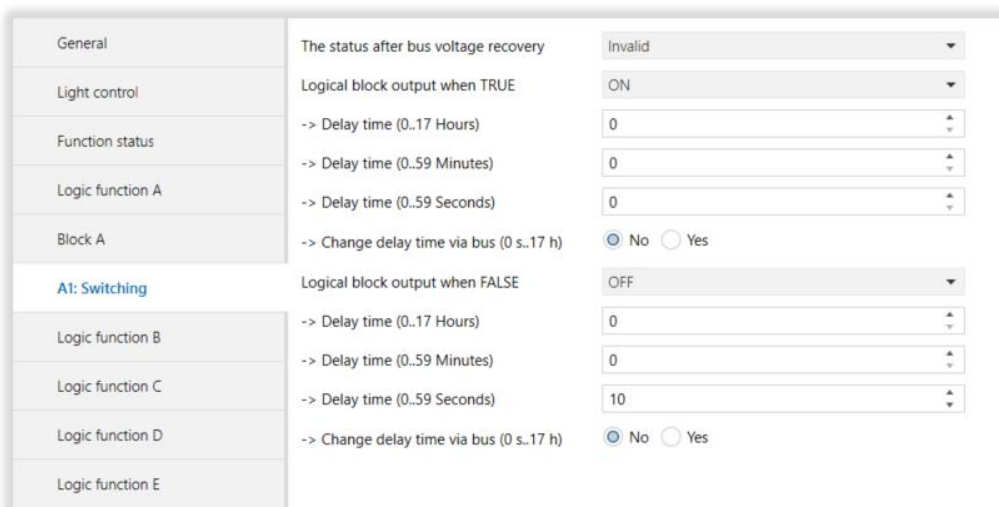

Fig 13 : A1:Switching Parameter Page

3.9.1. Parameters List

PARAMETERS	DESCRIPTION	VALUES
The status after bus voltage recovery	This parameter, is used to set the status after bus voltage recovery.	Invalid ON OFF Recovery
Logical block output when TRUE	This parameter, is used to set the function when logic block output is true.	Invalid OFF ON Toggle
-> Delay time (0...17 Hours)	This parameter, is used to set the time delay in hours.	0...17
-> Delay time (0...59 Min)	This parameter, is used to set the time delay in minutes.	0...59

-> Delay time (0...59 Sec)	This parameter, is used to set the time delay in seconds.	0...59
-> Change delay time via bus (0s...17h)	This parameter, is used to set the changing delay time via bus. Yes: The delay time can be changed via bus. No: The delay time can not be changed via bus.	Yes No
Logical block output when FALSE	This parameter, is used to set the function when logic block output is false.	Invalid OFF ON Toggle
-> Delay time (0...17 Hours)	This parameter, is used to set the time delay in hours.	0...17
-> Delay time (0...59 Min)	This parameter, is used to set the time delay in minutes.	0...59
-> Delay time (0...59 Sec)	This parameter, is used to set the time delay in seconds.	0...10...59
-> Change delay time via bus (0s...17h)	This parameter, is used to set the changing delay time via bus. Yes: The delay time can be changed via bus. No: The delay time can not be changed via bus.	Yes No

3.10. A1: DIMMING

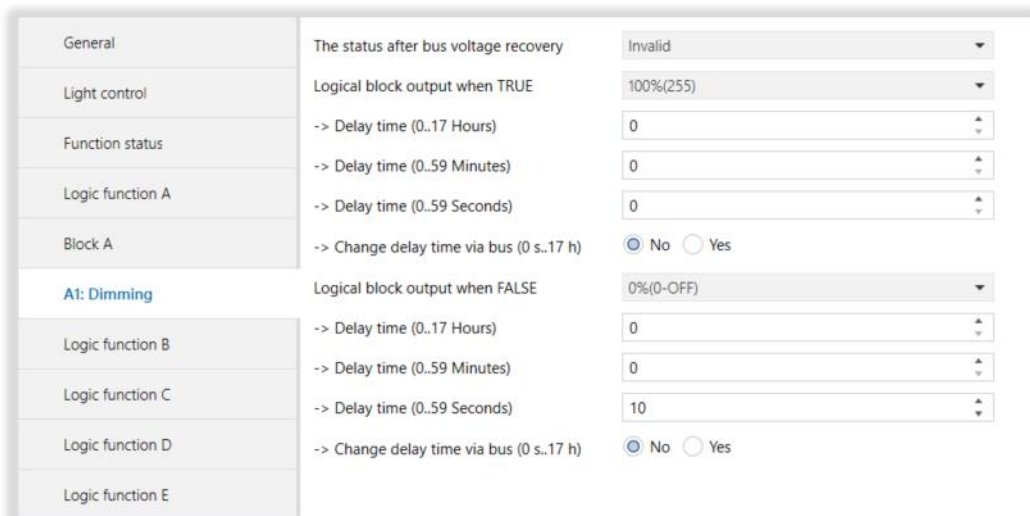

Fig 14 : A1:Dimming Parameter Page

3.10.1. Parameters List

PARAMETERS	DESCRIPTION	VALUES
The status after bus voltage recovery	This parameter, is used to set the status after bus voltage recovery.	Invalid Recovery Defined dimming
-> Recovery defined dimming	This parameter, is used to set the recovery defined dimming value after bus voltage recovery.	Invalid 0%(0-OFF)...100%(255)
Logical block output when TRUE	This parameter, is used to set the function when logic block output is true.	Invalid 0%(0-OFF)...100%(255)
-> Delay time (0...17 Hours)	This parameter, is used to set the time delay in hours.	0...17
-> Delay time (0...59 Min)	This parameter, is used to set the time delay in minutes.	0...59
-> Delay time (0...59 Sec)	This parameter, is used to set the time delay in seconds.	0...59
-> Change delay time via bus (0s...17h)	This parameter, is used to set the changing delay time via bus. Yes: The delay time can be changed via bus. No: The delay time can not be changed via bus.	Yes No
Logical block output when FALSE	This parameter, is used to set the function when logic block output is false.	Invalid 0%(0-OFF)...100%(255)
-> Delay time (0...17 Hours)	This parameter, is used to set the time delay in hours.	0...17
-> Delay time (0...59 Min)	This parameter, is used to set the time delay in minutes.	0...59
-> Delay time (0...59 Sec)	This parameter, is used to set the time delay in seconds.	0...10...59
-> Change delay time via bus (0s...17h)	This parameter, is used to set the changing delay time via bus. Yes: The delay time can be changed via bus. No: The delay time can not be changed via bus.	Yes No

3.11. A1:SHUTTER

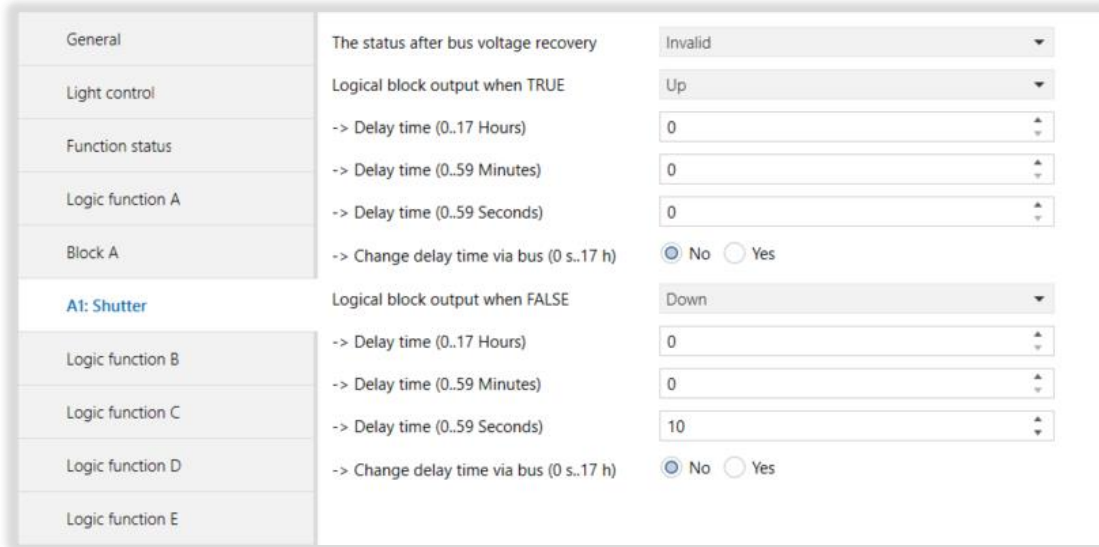

Fig 15 : A1:Shutter Parameter Page

3.11.1. Parameters List

PARAMETERS	DESCRIPTION	VALUES
The status after bus voltage recovery	This parameter, is used to set the status after bus voltage recovery.	Invalid UP Down Recovery
Logical block output when TRUE	This parameter, is used to set the function when logic block output is true.	Invalid Up Down Toggle
-> Delay time (0...17 Hours)	This parameter, is used to set the time delay in hours.	0...17
-> Delay time (0...59 Min)	This parameter, is used to set the time delay in minutes.	0...59
-> Delay time (0...59 Sec)	This parameter, is used to set the time delay in seconds.	0...59
-> Change delay time via bus (0s...17h)	This parameter, is used to set the changing delay time via bus. Yes: The delay time can be changed via bus. No: The delay time can not be changed via bus.	Yes No

Logic block output when FALSE	This parameter, is used to set the function when logic block output is false.	Invalid 0%(0-OFF)...100%(255)
-> Delay time (0...17 Hours)	This parameter, is used to set the time delay in hours.	0...17
-> Delay time (0...59 Min)	This parameter, is used to set the time delay in minutes.	0...59
-> Delay time (0...59 Sec)	This parameter, is used to set the time delay in seconds.	0...10...59
-> Change delay time via bus (0s...17h)	This parameter, is used to set the changing delay time via bus. Yes: The delay time can be changed via bus. No: The delay time can not be changed via bus.	Yes No

3.12. A1:ALARM

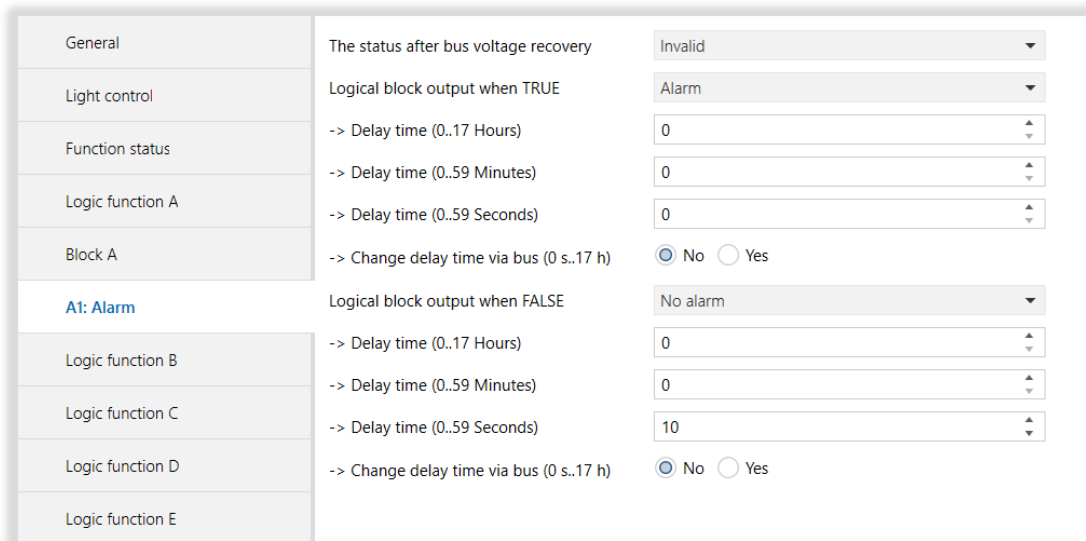

Fig 16 : A1:Alarm Parameter Page

3.12.1. Parameters List

PARAMETERS	DESCRIPTION	VALUES
The status after bus voltage recovery	This parameter, is used to set the status after bus voltage recovery.	Invalid UP Down Recovery

Logical block output when TRUE	This parameter, is used to set the function when logic block output is true.	Invalid Up Down Toggle
-> Delay time (0...17 Hours)	This parameter, is used to set the time delay in hours.	0...17
-> Delay time (0...59 Min)	This parameter, is used to set the time delay in minutes.	0...59
-> Delay time (0...59 Sec)	This parameter, is used to set the time delay in seconds.	0...59
-> Change delay time via bus (0s...17h)	This parameter, is used to set the changing delay time via bus. Yes: The delay time can be changed via bus. No: The delay time can not be changed via bus.	Yes No
Logic block output when FALSE	This parameter, is used to set the function when logic block output is false.	Invalid 0%(0-OFF)...100%(255)
-> Delay time (0...17 Hours)	This parameter, is used to set the time delay in hours.	0...17
-> Delay time (0...59 Min)	This parameter, is used to set the time delay in minutes.	0...59
-> Delay time (0...59 Sec)	This parameter, is used to set the time delay in seconds.	0...10...59
-> Change delay time via bus (0s...17h)	This parameter, is used to set the changing delay time via bus. Yes: The delay time can be changed via bus. No: The delay time can not be changed via bus.	Yes No

3.13. A1:PERCENTAGE CONTROL

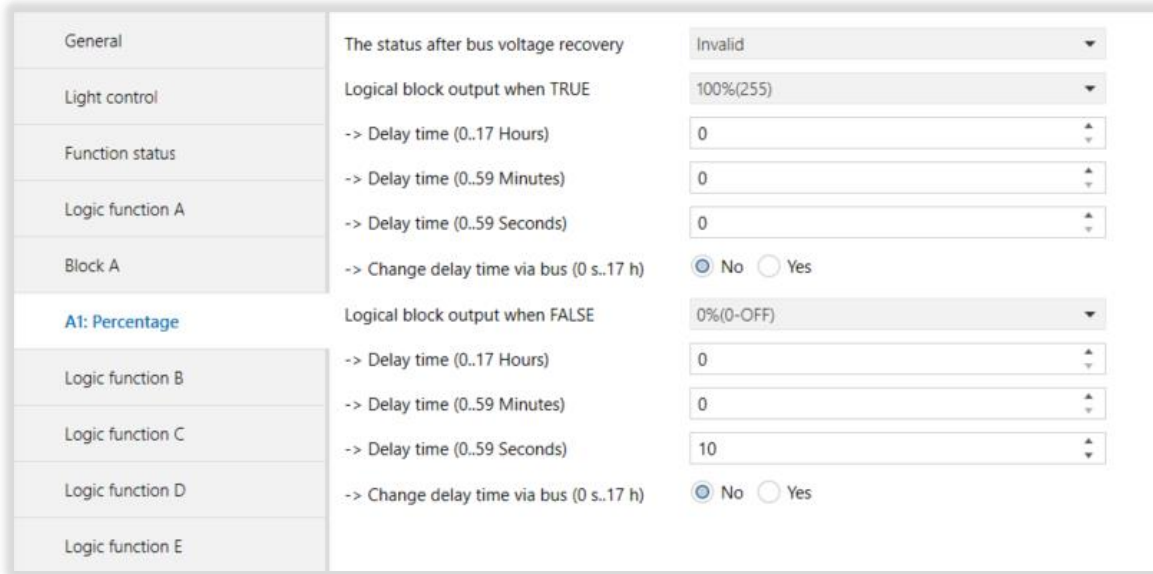

Fig 17 : A1:Percentage Control Parameter Page

3.13.1. Parameters List

PARAMETERS	DESCRIPTION	VALUES
The status after bus voltage recovery	This parameter, is used to set the status after bus voltage recovery.	Invalid UP Down Recovery
-> Recovery defined percentage	This parameter is used to set the value that the function will take after a power failure.	0%(0-OFF)...100%(255)
Logical block output when TRUE	This parameter, is used to set the function when logic block output is true.	Invalid Up Down Toggle
-> Delay time (0...17 Hours)	This parameter, is used to set the time delay in hours.	0...17
-> Delay time (0...59 Min)	This parameter, is used to set the time delay in minutes.	0...59
-> Delay time (0...59 Sec)	This parameter, is used to set the time delay in seconds.	0...59

-> Change delay time via bus (0s...17h)	This parameter, is used to set the changing delay time via bus. Yes: The delay time can be changed via bus. No: The delay time can not be changed via bus.	Yes No
Logic block output when FALSE	This parameter, is used to set the function when logic block output is false.	Invalid 0%(0-OFF)...100%(255)
-> Delay time (0...17 Hours)	This parameter, is used to set the time delay in hours.	0...17
-> Delay time (0...59 Min)	This parameter, is used to set the time delay in minutes.	0...59
-> Delay time (0...59 Sec)	This parameter, is used to set the time delay in seconds.	0...10...59
-> Change delay time via bus (0s...17h)	This parameter, is used to set the changing delay time via bus. Yes: The delay time can be changed via bus. No: The delay time can not be changed via bus.	Yes No

3.14. A1:SEQUENCE CONTROL

The screenshot displays the 'A1: Sequence' control page. On the left is a navigation menu with options: General, Light control, Function status, Logic function A, Block A, **A1: Sequence**, Logic function B, Logic function C, Logic function D, and Logic function E. The main content area is divided into two sections:

- Top Section:**
 - 'The status after bus voltage recovery' is set to 'Invalid'.
 - 'Logical block output when TRUE' is set to 'Start'.
 - '-> Delay time (0..17 Hours)' is set to 0.
 - '-> Delay time (0..59 Minutes)' is set to 0.
 - '-> Delay time (0..59 Seconds)' is set to 0.
 - '-> Change delay time via bus (0 s..17 h)' has radio buttons for 'No' (selected) and 'Yes'.
- Bottom Section:**
 - 'Logical block output when FALSE' is set to 'Stop'.
 - '-> Delay time (0..17 Hours)' is set to 0.
 - '-> Delay time (0..59 Minutes)' is set to 0.
 - '-> Delay time (0..59 Seconds)' is set to 10.
 - '-> Change delay time via bus (0 s..17 h)' has radio buttons for 'No' (selected) and 'Yes'.

Fig 18 : A1:Sequence Control Parameter Page

3.14.1. Parameters List

PARAMETERS	DESCRIPTION	VALUES
The status after bus voltage recovery	This parameter, is used to set the status after bus voltage recovery.	Invalid UP Down Recovery
Logical block output when TRUE	This parameter, is used to set the function when logic block output is true.	Invalid Up Down Toggle
-> Delay time (0...17 Hours)	This parameter, is used to set the time delay in hours.	0...17
-> Delay time (0...59 Min)	This parameter, is used to set the time delay in minutes.	0...59
-> Delay time (0...59 Sec)	This parameter, is used to set the time delay in seconds.	0...59
-> Change delay time via bus (0s...17h)	This parameter, is used to set the changing delay time via bus. Yes: The delay time can be changed via bus. No: The delay time can not be changed via bus.	Yes No
Logic block output when FALSE	This parameter, is used to set the function when logic block output is false.	Invalid 0%(0-OFF)...100%(255)
-> Delay time (0...17 Hours)	This parameter, is used to set the time delay in hours.	0...17
-> Delay time (0...59 Min)	This parameter, is used to set the time delay in minutes.	0...59
-> Delay time (0...59 Sec)	This parameter, is used to set the time delay in seconds.	0...10...59
-> Change delay time via bus (0s...17h)	This parameter, is used to set the changing delay time via bus. Yes: The delay time can be changed via bus. No: The delay time can not be changed via bus.	Yes No

3.15. A1:SCENE CONTROL

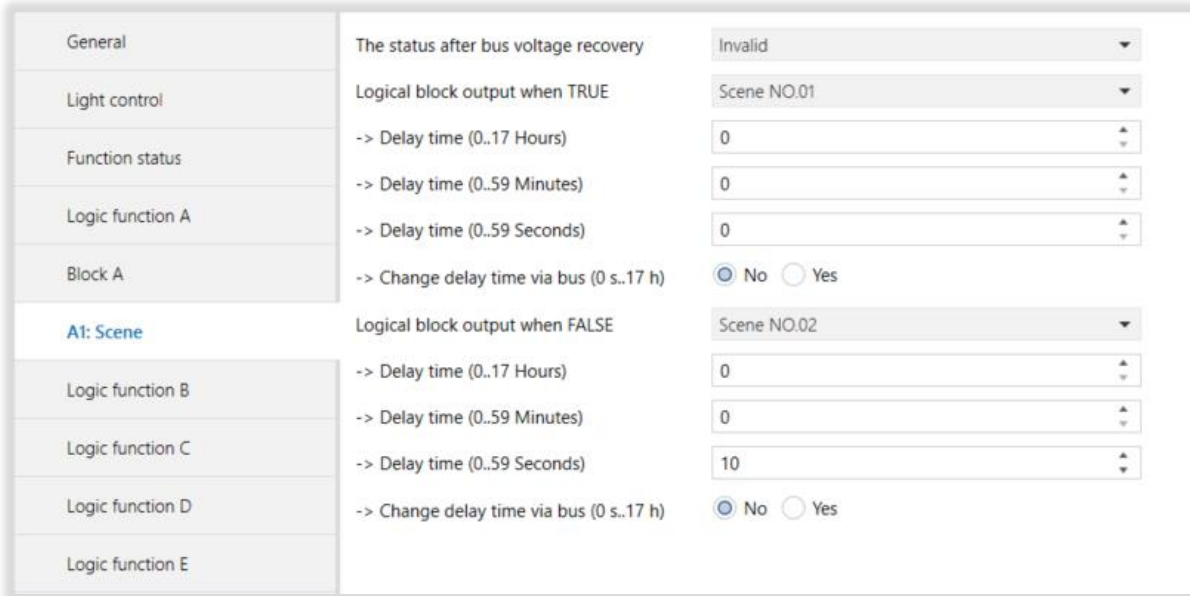

Fig 19 : A1:Scene Control Parameter Page

3.15.1. Parameters List

PARAMETERS	DESCRIPTION	VALUES
The status after bus voltage recovery	This parameter, is used to set the status after bus voltage recovery.	Invalid UP Down Recovery
Recovery defined scene NO.	This parameter is used to set the scene that the function will take after a power failure.	Scene NO.01..Scene NO.64
Logical block output when TRUE	This parameter, is used to set the function when logic block output is true.	Invalid Up Down Toggle
-> Delay time (0...17 Hours)	This parameter, is used to set the time delay in hours.	0...17
-> Delay time (0...59 Min)	This parameter, is used to set the time delay in minutes.	0...59
-> Delay time (0...59 Sec)	This parameter, is used to set the time delay in seconds.	0...59

-> Change delay time via bus (0s...17h)	This parameter, is used to set the changing delay time via bus. Yes: The delay time can be changed via bus. No: The delay time can not be changed via bus.	Yes No
Logic block output when FALSE	This parameter, is used to set the function when logic block output is false.	Invalid 0%(0-OFF)...100%(255)
-> Delay time (0...17 Hours)	This parameter, is used to set the time delay in hours.	0...17
-> Delay time (0...59 Min)	This parameter, is used to set the time delay in minutes.	0...59
-> Delay time (0...59 Sec)	This parameter, is used to set the time delay in seconds.	0...10...59
-> Change delay time via bus (0s...17h)	This parameter, is used to set the changing delay time via bus. Yes: The delay time can be changed via bus. No: The delay time can not be changed via bus.	Yes No

3.16. A1:STRING

The screenshot shows a configuration interface for the 'A1:String' parameter. The interface is divided into several sections:

- General:** The status after bus voltage recovery is set to Invalid and Defined string.
- Light control:** TRUE is valid? is set to No and Yes.
- Function status:** Logical block output when TRUE (14 Byte) is set to 'Hello world!'.
- Logic function A:**
 - > Delay time (0..17 Hours): 0
 - > Delay time (0..59 Minutes): 0
- Block A:**
 - > Delay time (0..59 Seconds): 0
- A1: String (highlighted):**
 - > Change delay time via bus (0 s..17 h): No and Yes.
 - FALSE is valid?: No and Yes.
 - Logical block output when FALSE (14 Byte): 'Hello world!'.
 - > Delay time (0..17 Hours): 0
 - > Delay time (0..59 Minutes): 0
 - > Delay time (0..59 Seconds): 10
 - > Change delay time via bus (0 s..17 h): No and Yes.
- Logic function B, C, D, E:** Each has a 'Delay time' dropdown menu.

Fig 20 : A1:String Parameter Page

3.16.1. Parameters List

PARAMETERS	DESCRIPTION	VALUES
The status after bus voltage recovery	This parameter, is used to set the status after bus voltage recovery.	Invalid Defined String
Recovery defined string (14 Byte)	This parameter, is used to set the recovery defined string after bus voltage recovery(14 byte).	Hello world!
TRUE is valid?	This parameter, is used to enable or disable for true value is valid. True: True is valid. No: True is invalid.	Yes No
Logical block output when TRUE (14 byte)	This parameter, is used to set the function when logic block output is true(14 byte).	Hello world!
-> Delay time (0...17 Hours)	This parameter, is used to set the time delay in hours.	0...17
-> Delay time (0...59 Min)	This parameter, is used to set the time delay in minutes.	0...59
-> Delay time (0...59 Sec)	This parameter, is used to set the time delay in seconds.	0...59
-> Change delay time via bus (0s...17h)	This parameter, is used to set the changing delay time via bus. Yes: The delay time can be changed via bus. No: The delay time can not be changed via bus.	Yes No
FALSE is valid?	This parameter, is used to enable or disable for false value is valid. True: False is valid. No: False is invalid.	Yes No
Logical block output when FALSE (14 byte)	This parameter, is used to set the function when logic block output is false.	Hello world!
-> Delay time (0...17 Hours)	This parameter, is used to set the time delay in hours.	0...17
-> Delay time (0...59 Min)	This parameter, is used to set the time delay in minutes.	0...59
-> Delay time (0...59 Sec)	This parameter, is used to set the time delay in seconds.	0...10...59
-> Change delay time via bus (0s...17h)	This parameter, is used to set the changing delay time via bus. Yes: The delay time can be changed via bus. No: The delay time can not be changed via bus.	Yes No

3.17. A1:THRESHOLD CONTROL

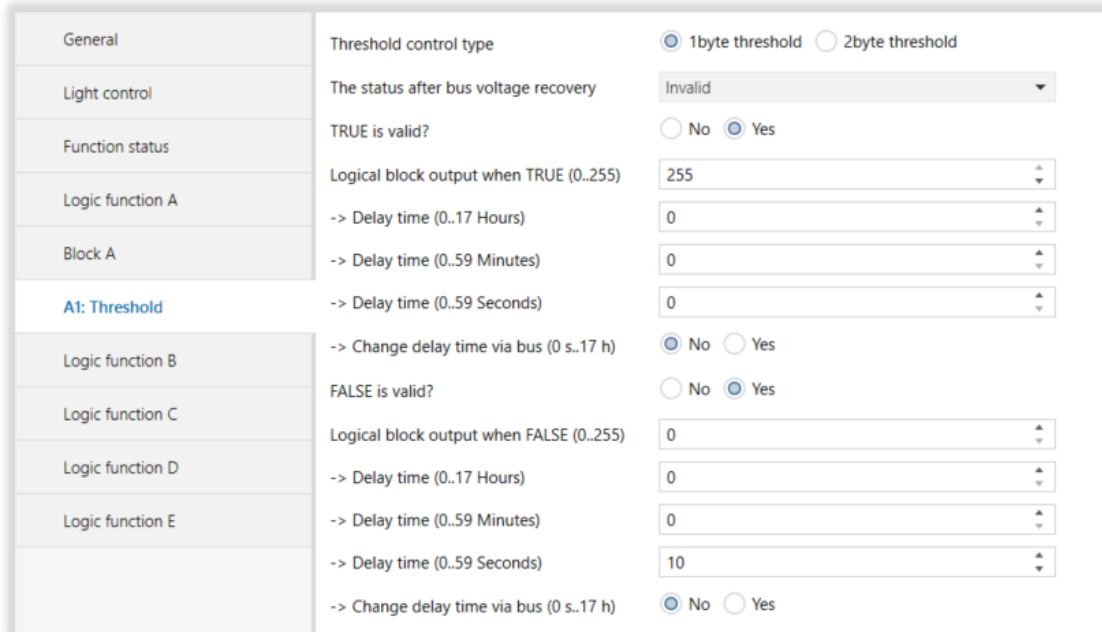

Fig 21 : A1:Threshold Parameter Page

3.17.1. Parameters List

PARAMETERS	DESCRIPTION	VALUES
Threshold control type	This parameter, is used to set the threshold control type.	1 byte threshold 2 byte threshold
The status after bus voltage recovery	This parameter, is used to set the status after bus voltage recovery.	Invalid Recovery Defined threshold
Recovery defined threshold (0...255)	This parameter, is used to set the recovery defined threshold after bus voltage recovery.	0...1...255
Recovery defined threshold (0...65535)	This parameter, is used to set the recovery defined threshold after bus voltage recovery.	0...65535
TRUE is valid?	This parameter, is used to enable or disable for true value is valid. True: True is valid. No: True is invalid.	Yes No
Logical block output when TRUE (0...255)	This parameter, is used to set the function when logical block output value is True(1 byte).	0...255
Logical block output when TRUE (0...65535)	This parameter, is used to set the function when logical block output value is True(2 byte).	0...1000...65535

-> Delay time (0...17 Hours)	This parameter, is used to set the time delay in hours.	0...17
-> Delay time (0...59 Min)	This parameter, is used to set the time delay in minutes.	0...59
-> Delay time (0...59 Sec)	This parameter, is used to set the time delay in seconds.	0...59
-> Change delay time via bus (0s...17h)	This parameter, is used to set the changing delay time via bus. Yes: The delay time can be changed via bus. No: The delay time can not be changed via bus.	Yes No
FALSE is valid?	This parameter, is used to enable or disable for false value is valid. True: False is valid. No: False is invalid.	Yes No
Logical block output when FALSE (0...255)	This parameter, is used to set the function when logical block output value is False(1 byte).	0...255
Logical block output when FALSE (0...65535)	This parameter, is used to set the function when logical block output value is False(2 byte).	0...65535
-> Delay time (0...17 Hours)	This parameter, is used to set the time delay in hours.	0...17
-> Delay time (0...59 Min)	This parameter, is used to set the time delay in minutes.	0...59
-> Delay time (0...59 Sec)	This parameter, is used to set the time delay in seconds.	0...10...59
-> Change delay time via bus (0s...17h)	This parameter, is used to set the changing delay time via bus. Yes: The delay time can be changed via bus. No: The delay time can not be changed via bus.	Yes No

3.18. Logic Function E

General	Use logical block E	<input type="radio"/> No <input checked="" type="radio"/> Yes
Light control	Enable logic A	<input checked="" type="radio"/> Disable <input type="radio"/> Enable
Function status	Enable logic B	<input checked="" type="radio"/> Disable <input type="radio"/> Enable
Logic function A	Enable logic C	<input checked="" type="radio"/> Disable <input type="radio"/> Enable
Block A	Enable logic D	<input checked="" type="radio"/> Disable <input type="radio"/> Enable
A1: Threshold	Result of logic E inverted	<input type="radio"/> No <input checked="" type="radio"/> Yes
A2: Percentage	NOTE: Logic E = A o B o C o D (o = AND/OR)	
Logic function B	Status(True/False) of logic E to bus	<input type="radio"/> Disable <input checked="" type="radio"/> Enable
Block B	->Send status when	Status changed
B1: Switching	<1>Use logical E function lock?	<input type="radio"/> No <input checked="" type="radio"/> Yes
Logic function C	->Use telegram via bus?	<input type="radio"/> No <input checked="" type="radio"/> Yes
Block C	-->>Operation mode	'1'-Unlock,'0'-Lock
C1: Switching	->Logic E output status when logic function lock	False and immediately output
Logic function D	->Logic E automatic unlock after logic function lock	<input type="radio"/> No <input checked="" type="radio"/> Yes
Block D	-->>Delay time (0..17 Hours)	0
D1: Switching	-->>Delay time (0..59 Minutes)	0
	-->>Delay time (0..59 Seconds)	30
Logic function E	<2>Use logical E function lock?	<input checked="" type="radio"/> No <input type="radio"/> Yes
Block E	Logic E output status when logic function unlock	True
E1: Switching	Feedback logic E function lock status	<input checked="" type="radio"/> No <input type="radio"/> Yes

Fig 22 : Logic Function E Parameter Page

3.18.1. Parameters List

PARAMETERS	DESCRIPTION	VALUES
Use logic block E	This parameter, is used to enable or disable the logic block E.	No Yes
Enable logic A-D	These parameters, are used to enable or disable the logic A-D blocks.	Disable Enable
->Result of logic A-E inverted	This parameter, is used to enable or disable the inverse of the value obtained as a result of the logic A-E blocks.	No Yes

<p>Logic relation</p>	<p>This parameter, is used to set logic relations.</p> <p>AND : If all logical values (A-D) are true, logic E generates a value of true.</p> <p>OR : If any logic value (A-D) is true, logic E generates a value of true.</p>	<p>AND</p> <p>OR</p>
<p>Status(True/False) of logic E to bus</p>	<p>This parameter, is used to enable or disable the sending of the status of the logic E to the bus line.</p>	<p>Disable</p> <p>Enable</p>
<p>-> Send status when</p>	<p>This parameter, is used to set the condition for sending status information.</p>	<p>Status changed</p> <p>Status is True</p> <p>Status if false</p> <p>Status changed and periodically</p> <p>Status is True and periodically</p> <p>Status is False and periodically</p>
<p>Use logical E function lock?</p>	<p>This parameter, is used to enable or disable the logic E function lock feature.</p>	<p>Yes</p> <p>No</p>
<p>->Use telegram via bus?</p>	<p>This parameter, is used to enable or disable the use of telegram via bus line.</p>	<p>No</p> <p>Yes</p>
<p>-->>Operation mode</p>	<p>This parameter, is used to set the operation mode.</p>	<p>'1' -Unlock, '0' -Lock</p> <p>'1' -Lock, '0' -Unlock</p> <p>'1/0' -Lock</p> <p>'1/0' -Unlock</p> <p>'1' -Unlock, '0' -Invalid</p> <p>'0' -Lock, '1' -Invalid</p> <p>'1' -Lock, '0' -Invalid</p>
<p>-Logic E output status when logic function lock</p>	<p>This parameter, is used to set logic E output status when logic function lock.</p>	<p>False and immediately output</p> <p>Unchanged</p> <p>True</p> <p>False</p> <p>True and immediately output</p>
<p>-Logic E automatic unlock after logic function lock</p>	<p>This parameter, is used to enable or disable the automatic unlock after logic function lock.</p>	<p>No</p> <p>Yes</p>
<p>-->> Delay time (0...17 Hours)</p>	<p>This parameter, is used to set the time delay in hours.</p>	<p>0...17</p>

-->> Delay time (0...59 Min)	This parameter, is used to set the time delay in minutes.	0...59
-->> Delay time (0...59 Sec)	This parameter, is used to set the time delay in seconds.	0...10...59
-Logic E output status when logic function unlock	This parameter, is used to set logic E output status when logic function unlock.	True False True and immediately output
Feedback logic function lock status	This parameter, is used to enable or disable feedback logic function lock status.	Yes No

4. ETS OBJECTS AND DESCRIPTIONS

It was mentioned above that there are parameters and functions with the same feature when making the relevant configurations from the parameter pages. The objects of the same properties are the same, and only the names of the objects are different. Hence, in this section, 1 of the objects with the same feature is explained.

4.1. GENERAL

At the following table, the objects associated with the general parameter page are described.

Object Name	Function	Type	Flags
General	Heartbeat telegram	1 bit	C T U
This communication object is always valid. If telegram '1' is sent, the next telegram value to be sent will be '0'.			
General	Movement sensor sensitivity	1 Byte	C W T U
This communication object is used to change movement sensor sensitivity. Sensitivity increases from 0% to 100%.			
Constant Brightness A	Dimming output value (0%...100%)	1 bit	C R T U
This communication object is used to set dimming output value. Brightness increases from 0% to 100%.			
Constant Brightness B	Dimming output value (0%...100%)	1 bit	C R T U
This communication object is used to set dimming output value. Brightness increases from 0% to 100%.			

4.2. LIGHT CONTROL

Object Name	Function	Type	Flags
Light channel 1,2 slave input	Movement status from bus	1 bit	C W U
This object, is used for the presence detector detects something in its detection zone. It will be send OFF-'0' or ON-'1' to the bus cycle, until does not detect any more movement. This function is often used to slave mode.			
Light channel 1,2 external input	External telegram	1 bit	C W U
This object, is used to receive telegram from external device, the condition was reached by value "1"-True of receiving telegram; The condition was not reached by value "0"-False of receiving telegram.			
Light channel 1,2 time input	Follow-up time (minutes)	2 bytes	C W U
This object, is used to set follow time via bus.			
Light channel 1,2 lux input	Brightness threshold	2 bytes	C W U
This object, is used to set lux threshold via bus. You can change the lux threshold by via bus.			
Light channel 1,2 lock input	'1' -lock, '0' -unlock	1 bit	C W U
This object, is used to set light channel 1/2 lock status. When the value is "1" light channel 1/2 will be locked, when value is "0" light channel 1/2 will be unlocked.			
Light channel 1,2 output	switching	1 bit	C R T U
This object, is used for switching function, when the logic block was reached, it will send ON or OFF telegram to the bus. After the logic block was not reached and delay over, it will send OFF or ON telegram to the bus.			
Light channel 1,2 output	Lock status feedback	1 bit	C R T U
This object, is used to set the lock status feedback. When "locked" or "unlocked" it will response different value.			

4.3. FUNCTION STATUS

Object Name	Function	Type	Flags
Function status	Slave status to bus	1 bit	C T U
This object, is used to respond status if detector detects something in its detection zone. When detects something it will response "on", else no response.			
Function status	Brightness (lux)value	2 bytes	C R T U
This object, is used to respond the brightness value. You can set report lux value if lux changed, also you can set report lux value circularly.			
Function status	Temperature value	2 bytes	C R T U
This object, is used to respond the temperature value. You can set report temperature value if temperature changed, also you can set report temperature value circularly.			

Function status	Slave status to bus (logic A)	1 bit	C W T U
-----------------	-------------------------------	-------	---------

This object, is used to respond status if detector detects something in its detection zone for logic A. When detects something it will response "on", else no response.

Function status	Slave status to bus (logic B,C,D)	1 bit	C R T U
-----------------	-----------------------------------	-------	---------

This object, is used to respond status if detector detects something in its detection zone for logic B, C, D. When detects something it will respond "on", else no response.

4.4. LOGIC FUNCTION A-E

Object Name	Function	Type	Flags
Object input A, B, C, D	Lux threshold A lower (0~1200)	2 bytes	C W T U

This object, is used to change the lower lux threshold value.

Object input A, B, C, D	Lux threshold A upper (0~1200)	2 bytes	C W T U
-------------------------	--------------------------------	---------	---------

This object, is used to change the upper lux threshold value.

Object input A, B, C, D	Lux threshold B independent	1 bit	C W T U
-------------------------	-----------------------------	-------	---------

This object, is used to set output result independent lux threshold B. If lux between lower set lux value and upper set value will output true else output false.

Object input A, B, C, D	Lux threshold C independent	1 bit	C W T U
-------------------------	-----------------------------	-------	---------

This object, is used to set output result independent lux threshold C. If lux between lower set lux value and upper set value will output true else output false.

Object input A, B, C, D	Temperature threshold lower	2 bytes	C W T U
-------------------------	-----------------------------	---------	---------

This object, is used to set lower temperature value.

Object input A, B, C, D	Temperature threshold upper	2 bytes	C W T U
-------------------------	-----------------------------	---------	---------

This object, is used to set upper temperature value.

Object input A, B, C, D	External telegram 1	1 bit	C W U
	1 bit value ('1' / '0')	1 byte	
	1 byte value (0...255)	2 bytes	
	2 bytes threshold (0...65525)	2 bytes	
	2 bytes float threshold (-50°C-100°C)	4 bytes	
	4 bytes threshold (0...2147483647)		

This object is used to set external telegram 1. If you select 1 bit value, you will set 1 or 0 as true or false value, when input 1 or 0, will output true or false. If you select 1 byte value, when your input value >= or <= the set value(0 to 255) will output true or false result. If you select 2 bytes value, when your input value >= or <= the set value(0 to 65535) will output true or

false result. If you select 2 bytes float threshold, when your input temperature value \geq or \leq the set value(-50°C to 100°C) will output true or false result. If you select 4 bytes threshold, when your input value \geq or \leq the set value(0 to 2147483647) will output true or false result.

Object input A, B, C, D	External telegram 2	1 bit	C W U
	1 bit value ('1' / '0')	1 byte	
	1 byte value (0...255)	2 bytes	
	2 bytes threshold (0...65525)	2 bytes	
	2 bytes float threshold (-50°C-100°C)	4 bytes	
	4 bytes threshold (0...2147483647)		

This object is used to set external telegram 2. If you select 1 bit value, you will set 1 or 0 as true or false value, when input 1 or 0, will output true or false. If you select 1 byte value, when your input value \geq or \leq the set value(0 to 255) will output true or false result. If you select 2 bytes value, when your input value \geq or \leq the set value(0 to 65535) will output true or false result. If you select 2 bytes float threshold, when your input temperature value \geq or \leq the set value(-50°C to 100°C) will output true or false result. If you select 4 bytes threshold, when your input value \geq or \leq the set value(0 to 2147483647) will output true or false result.

Object output A1, B1, C1, D1	Switch	1 bit	C R T U
	Absolute Dimming	1 byte	
	Shutter	1 bit	
	Alarm	1 bit	
	Percentage	1 byte	
	Sequence	1 bit	
	Scene	1 byte	
	String	14 byte	
	Threshold(1 byte)	1 byte	
	Threshold(2 bytes)	2 bytes	

This object, is used to set A1/B1/C1/D1 output function :

Switch : It is used for switching function, when the logic block was reached, it will send ON or OFF telegram to the bus. After logic block was not reached and delay over, it will send OFF or ON telegram to the bus.

Absolute Dimming : It is used for absolute dimming function, when the logic block was reached, it will send setting value to control brightness. After logic block was not reached and delay over, it will send another setting value.

Shutter : It is used for shutter function, when the logic block was reached, it will send Up or Down telegram to the bus. After the logic block was not reached and delay over, it will send Down or Up telegram to the bus.

Alarm : It is used for alarm function, when the logic block was reached, it will send Alarm or No alarm telegram to the bus. After the logic block was not reached and delay over, it will send No alarm or Alarm telegram to the bus.

Percentage : It is used for percentage function, when the logic block was reached, it will send setting value to control brightness. After the logic block was not reached and delay over, it will send another setting value.

Sequence : It is used for sequence function, when the logic block was reached, it will send start or stop telegram to the bus. After the logic block was not reached and delay over, it will send Stop or Start telegram to the bus.

Scene : It is used for scene function. 1 to 64 scene calls can be made.

String : It is used for string function, when the logic block was reached, it will send setting value to the bus. After the logic block was not reached and delay over, it will send another setting value.

Threshold(1 byte) : It is used for 1 byte threshold function, when the logic block was reached, it will send setting value 0-255 to bus. After the logic block was not reached and delay over, it will send another setting value.

Threshold(2 byte) : It is used for 2 byte threshold function, when the logic block was reached, it will send setting value 0-65535 to bus. After the logic block was not reached and delay over, it will send another setting value.

Object output A2, B2, C2, D2, E2	The same as above	The same as above	The same as above
Object output A3, B3, C3, D3, E3	The same as above	The same as above	The same as above
Object output A4, B4, C4, D4, E4	The same as above	The same as above	The same as above
Object output A5, B5, C5, D5, E5	The same as above	The same as above	The same as above
Object output A6, B6, C6, D6, E6	The same as above	The same as above	The same as above
Object output A7, B7, C7, D7, E7	The same as above	The same as above	The same as above
Object output A8, B8, C8, D8, E8	The same as above	The same as above	The same as above
Object output A9, B9, C9, D9, E9	The same as above	The same as above	The same as above
Object output A10, B10, C10, D10, E10	The same as above	The same as above	The same as above
Logic A, B, C, D, E status	1-true / 0-false	1 bit	C R T U

This object, is used to respond logic status. If logic is true will response true, else it will response false.

<1> Logic A, B, C, D, E function	Lock logic function	1 bit	C W T U
----------------------------------	---------------------	-------	---------

This object, is used to lock logic, so you can lock or unlock logic status.

<2> Logic A, B, C, D, E function	Lock logic function	1 bit	C W T U
----------------------------------	---------------------	-------	---------

This object, is used to lock logic, so you can lock or unlock logic status.

Logic A, B, C, D, E function	Lock status feedback	1 bit	C R T U
------------------------------	----------------------	-------	---------

This object, is used to response logic lock status. If logic is locked or unlocked, it will response disable or enable.

CONTACT INFORMATION

THE INTERRA WEB SITE

Interra provides documentation support via our WWW site www.interra.com.tr. This web site is used as a means to make files and information easily available to customers. Accessible by using your favorite Internet browser, the web site contains the following information:

- Information about our products and projects.
- Overview of Interra company and values.
- Product Support: Data sheets, product manuals, application descriptions, latest software releases, ETS databases and archived softwares.

Europe, Turkey

MID RANGE CEILING MOUNT PASSIVE INFRARED SENSOR - Product Manual

Interra

Cumhuriyet mh. Kartal cd. No:95/1

Simkan Plaza 34876 Kartal/İstanbul

Tel: +90 (216) 326 26 40 Fax: +90 (216) 324 25 03

Web adress: <http://www.interra.com.tr/>